

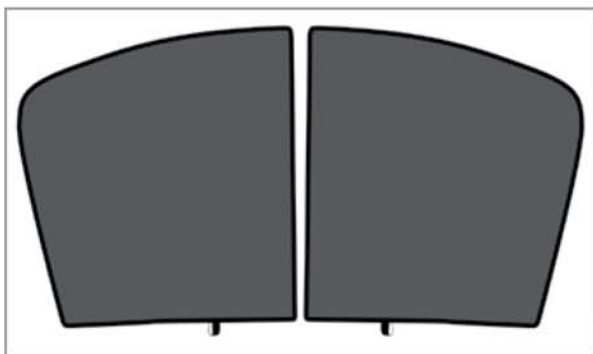

D	Einbauanleitung	Änderungen bezüglich Konstruktion, Ausstattung, Farbe sowie Irrtum vorbehalten. Angaben und Abbildungen unverbindlich.
GB	Installation instructions	Subject to change in terms of construction, equipment and colour, and may contain errors. The information and illustrations are non-binding.
F	Consignes de montage	Sous réserve de modifications de la construction, de l'équipement, de la couleur et sous réserve d'erreurs. Les indications et les illustrations sont sans engagement.
NL	Montagehandleiding	Wijzigingen met betrekking tot constructie, uitvoering en kleur eventueel vergissingen voorbehouden. Gegevens en afbeeldingen niet bindend.
DK	Montagevejledning	Ændringer med hensyn til konstruktion, udstyr, farver samt fejl forbeholdes. Oplysninger og illustrationer er uforpligtende.
N	Monteringsinstruksjon	Endringer angående konstruksjon, utstyr, farge og feiltagelse forbeholdes. Oplysninger og illustrasjoner uforbindtlig.
S	Installationsanvisning	Med reservation för ändringar vad det gäller konstruktion, utrustning, färg samt fel misstag. Uppgifterna och bilderna är inte bindande.
FIN	Asennusohje	Pidätämme oikeuden rakennetta, varustusta, väriä koskeviin sekä erehdyksestä johtuviin muutoksiin. Tiedot ja kuvat eivät ole sitovia.
I	Istruzioni per il montaggio	Con riserva di modifiche relative a progettazione, dotazione, colore ed errori. Le indicazioni e figure sono fornite senza impegno.
E	Instrucciones de montaje	Reservadas las modificaciones respecto a diseño, equipamiento, color, así como error. Indicaciones y figuras sin compromiso.
P	Instruções de montagem	Reservamos o direito de alterações relativamente ao desenho, equipamento, cor, bem como de erro. Os dados e as gravuras não implicam compromisso da nossa parte.
GR	Οδηγίες εγκατάστασης	Διατηρούμε κάθε επιφύλαξη ως προς αλλαγές σε σχέση με κατασκευή, εξοπλισμό, διαρρυθμίση, χροιάχρωματός και λάθη παραδρομής.
CZ	Návod k montáži	Změny týkající se konstrukce, vybavení, barvy, jakož i omyly jsou vyhrazeny. Údaje a vyzobrazení jsou nezávazné.
PL	Instrukcja montażu	Zastrzeżę się prawo do zmian dot. konstrukcji, wykończenia, kolorystyki oraz pomylek. Dane i ilustracje niewiązące.
TR	Montaj talimatı	Tasarım, donanım ve renk bakımından değişiklik yapma hakkı ve hata ve eksiklik mahfuzdur. Veriler ve resimler bağlayıcı değildir.
H	Beépítési útmutató	A szerkezet, a kivétel és a szín változtatása, valamint a változások joga fenntartva. Az adatok és az ábrák nem kötelező érvényűek.
HR	Upute o ugradnji	Pravo promjena u svezi konstrukcije, opreme, boje kao i zabune održavavamo. Podaci i ilustracije su neobavezne.
BUL	Инструкция за монтаж	Запазени права по отношение на конструкцията, оборудването, цвета и грешки. Данните и изображенията не са обвързващи.
RO	Instrucțiuni de montaj	Ne rezervăm dreptul unor modificări ale construcției, dotării, culorii și dreptul la erori. Datele indicate și imaginile sunt orientative.
RUS	Инструкция по монтажу и установке	Права на внесение изменений относительно конструкции, оснащения, окраски, а также на ошибки сохраняются. Данные и иллюстрации имеют примерный характер.
LT	Montavimo informacija	Pasilekama konstrukcijos, įrangos bei reikmenų, spalvos pakeitimų ir klaidų teisė. Duomenys ir iliustracijos neįpareigojantys.
LV	Iemontēšanas pamācība	Tiek paturētas tiesības uz konstrukcijas, iekārtu, krāsu izmaiņām, kā arī kļūdīšanās. Dati un attēli bez saistībām.
EST	Paigaldusjuhend	Konstruktiooni, varustuse ja värvri osas muudatuse ning eksimine lubatud. Andmed ja joonised on mitteisiduvad.
SLO	Navodilo za vgradnjo	Zadržana pravica do sprememb glede konstrukcije, opreme, barve ter pomote. Podatki in slike so neobvezne.
SK	Montážny návod	Zmeny, ktoré sa týkajú konštrukcie, vybavenia, farby, ako aj omyly sú vyhradené. Údaje a zobrazenia sú nezávazné.
J	取り付け説明書	構造、装飾、色に關しての変更、または間違いがある可能性が有ります。 記載事項および図に關して責任を負いません。
ROK	장치 지시사항	구조, 장치, 색채의 그의 오류정정이 변경, 오류함. 지시 사항과 사진물에 관해 책임을 지지 않음.
THA	คู่มือการติดตั้ง	การเปลี่ยนแปลงในโครงสร้าง อุปกรณ์ สี และภาพประกอบจะสงวนไว้ สงวนการเปลี่ยนแปลงในโครงสร้าง อุปกรณ์ สี และภาพประกอบจะสงวนไว้
VR	安装说明书	保留设计、配置、颜色以及错误的修改权。 给出的资料和插图均没有法律约束力。
VR	安裝說明書	保留設計、配置、顏色以及錯誤的修改權。 給出的資料和插圖均沒有法律約束力。

19202925 12/09

19202923



X2

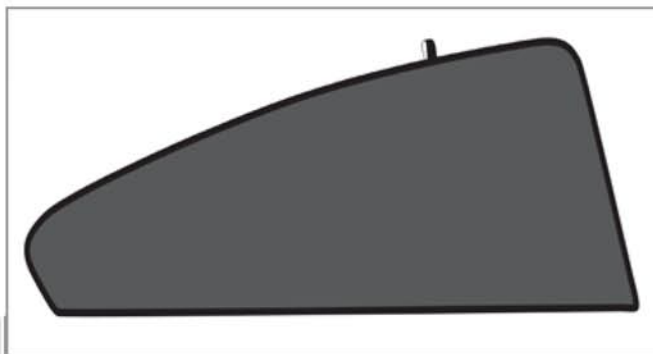

X2

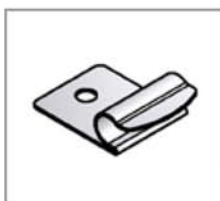

X4



X1



X2

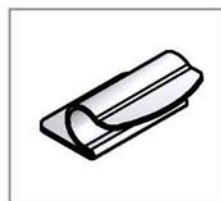

X2

1

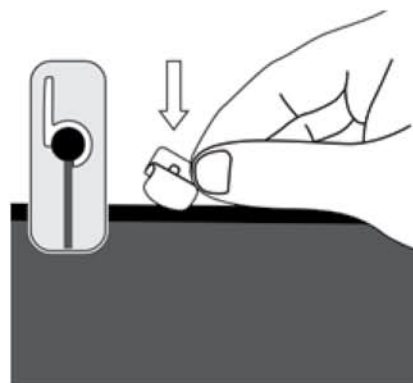
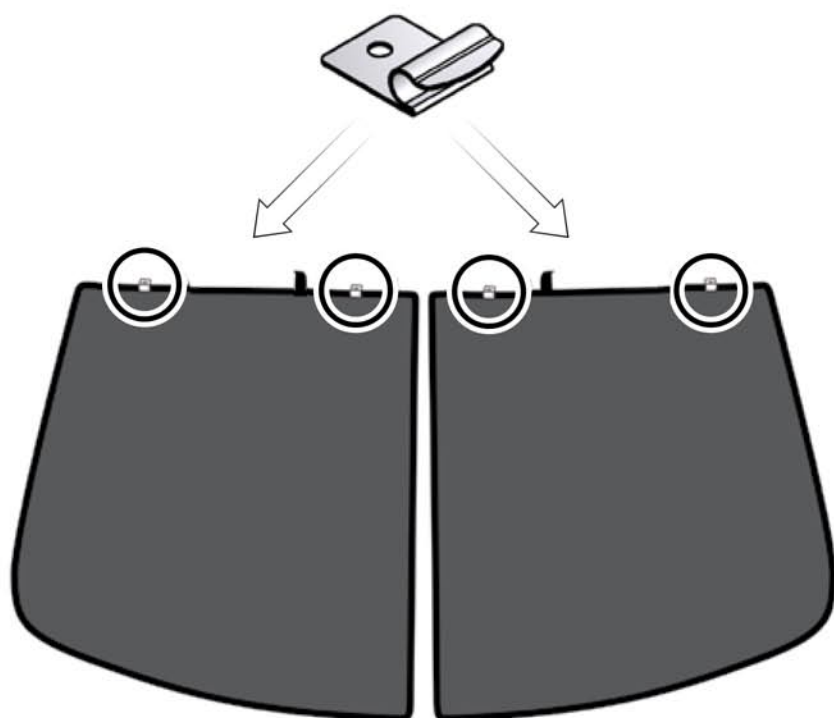

2

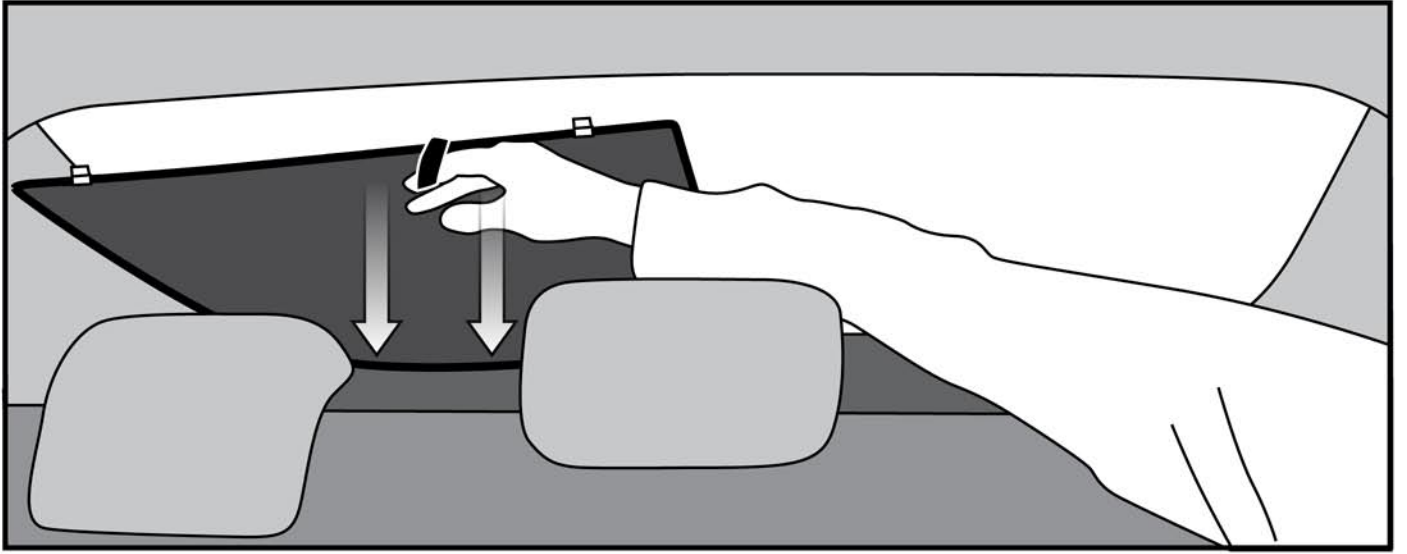

3

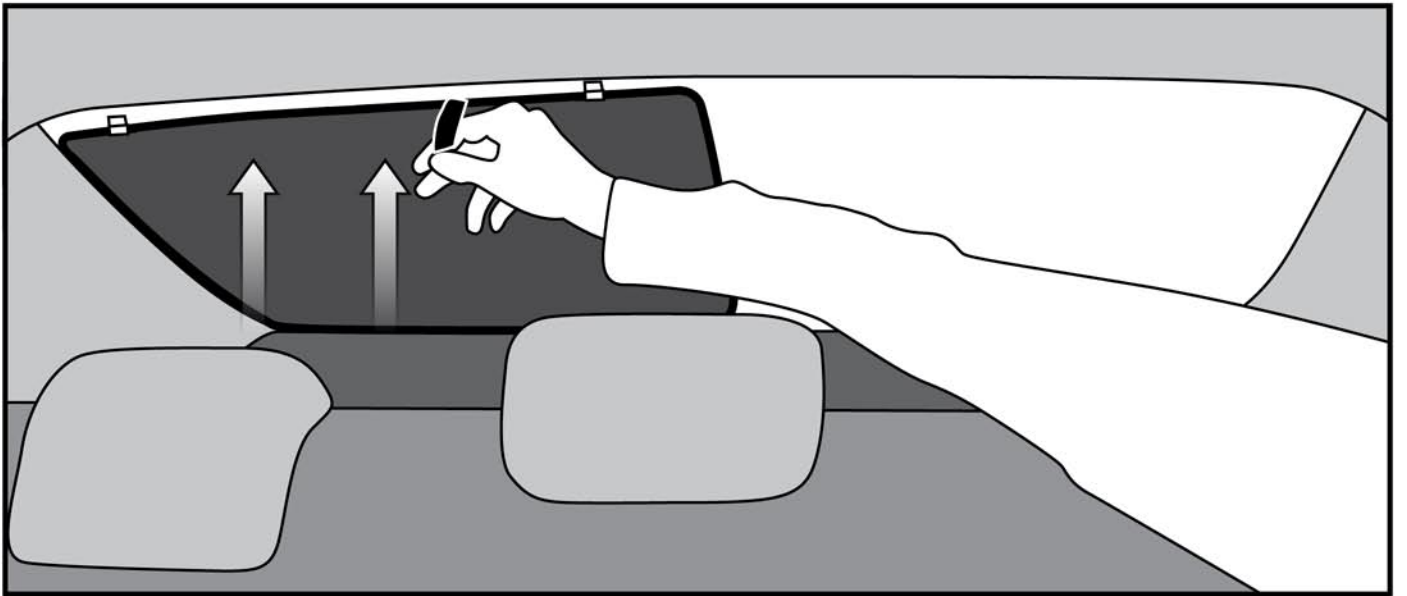

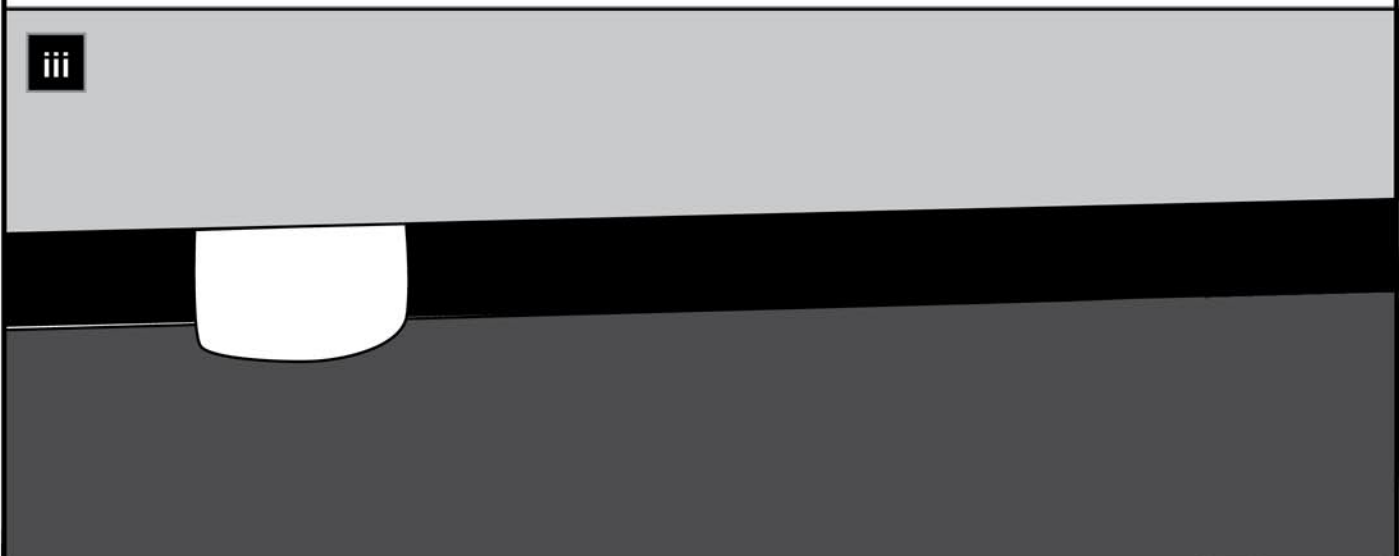
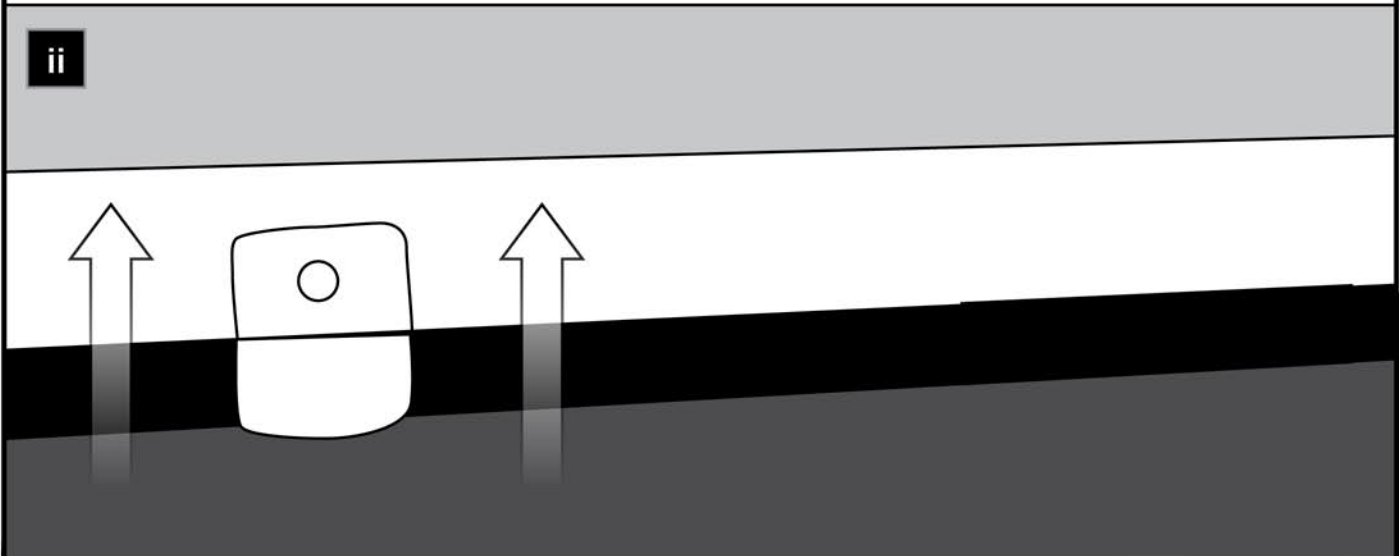
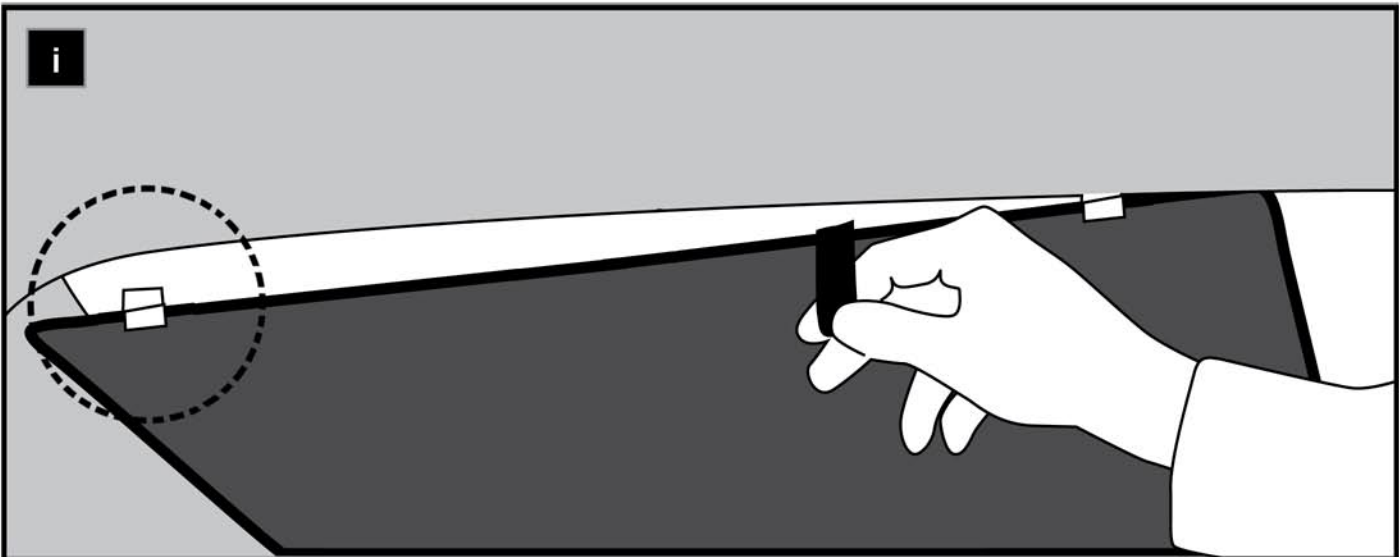

5

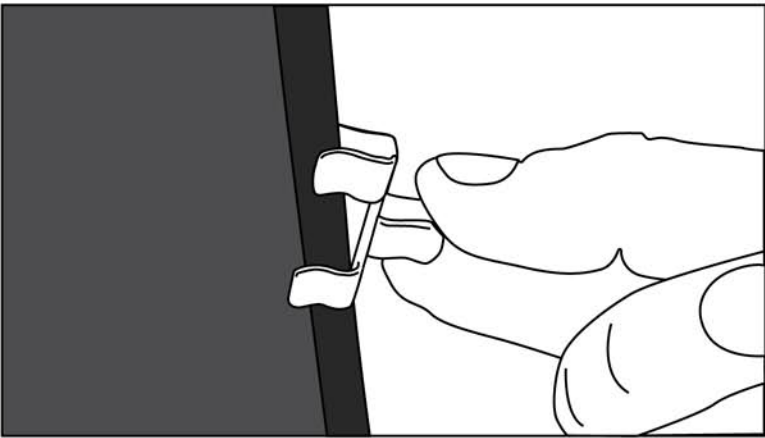
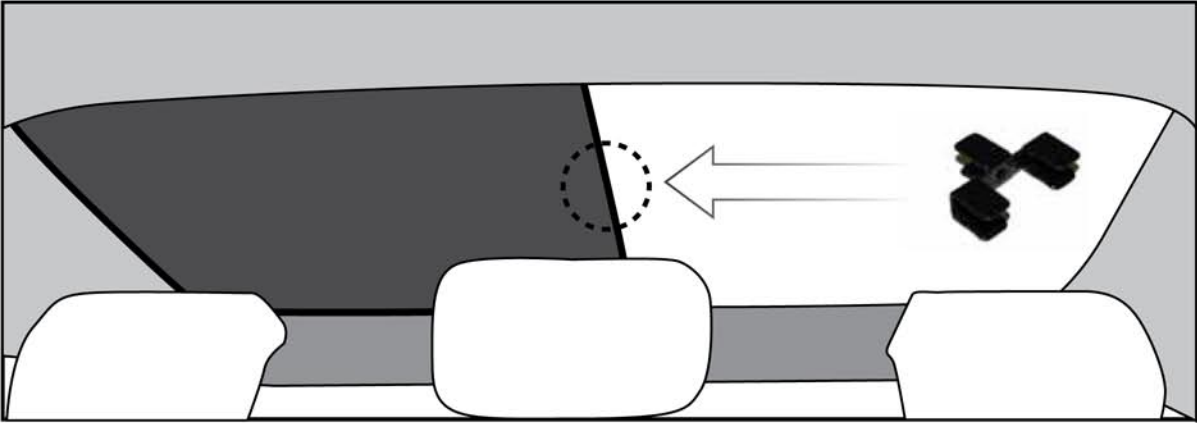

6

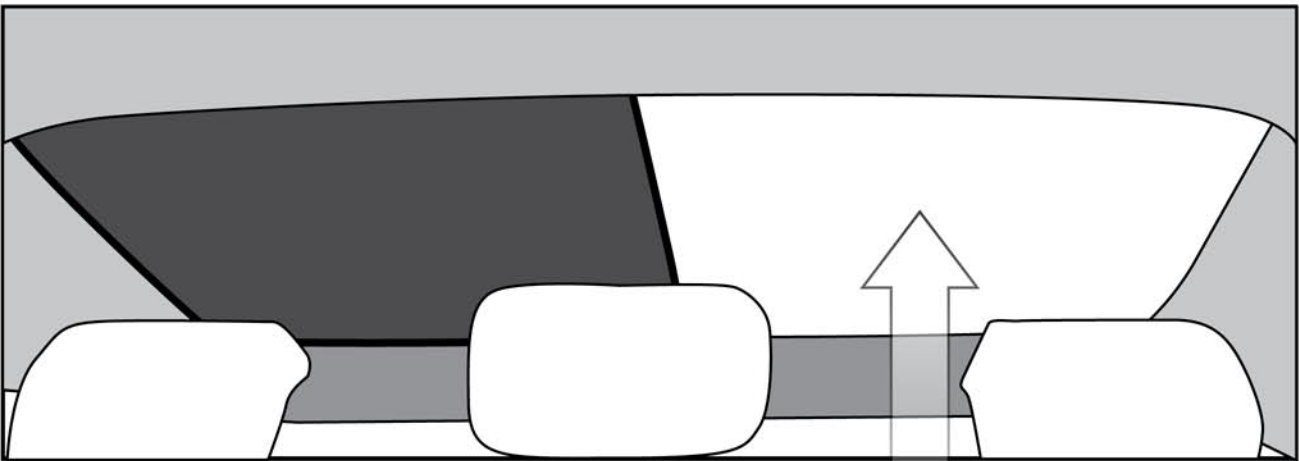

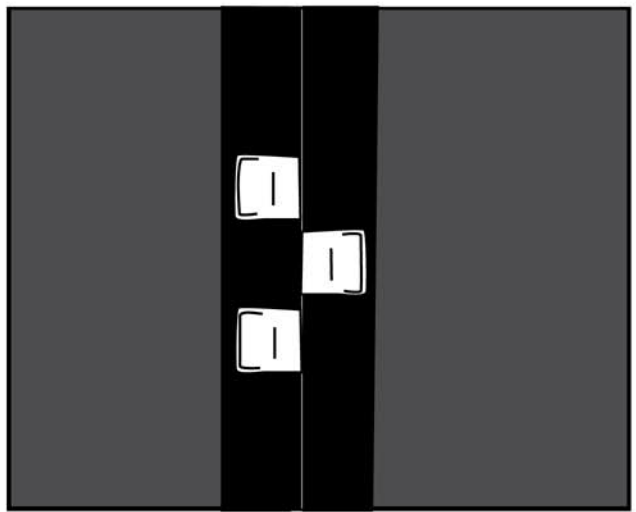
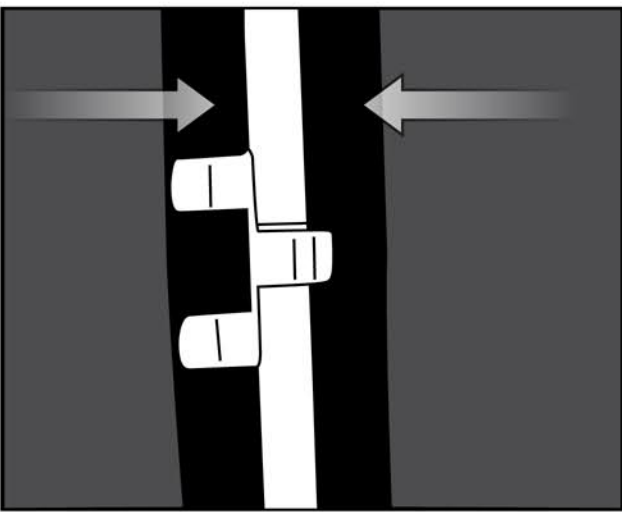
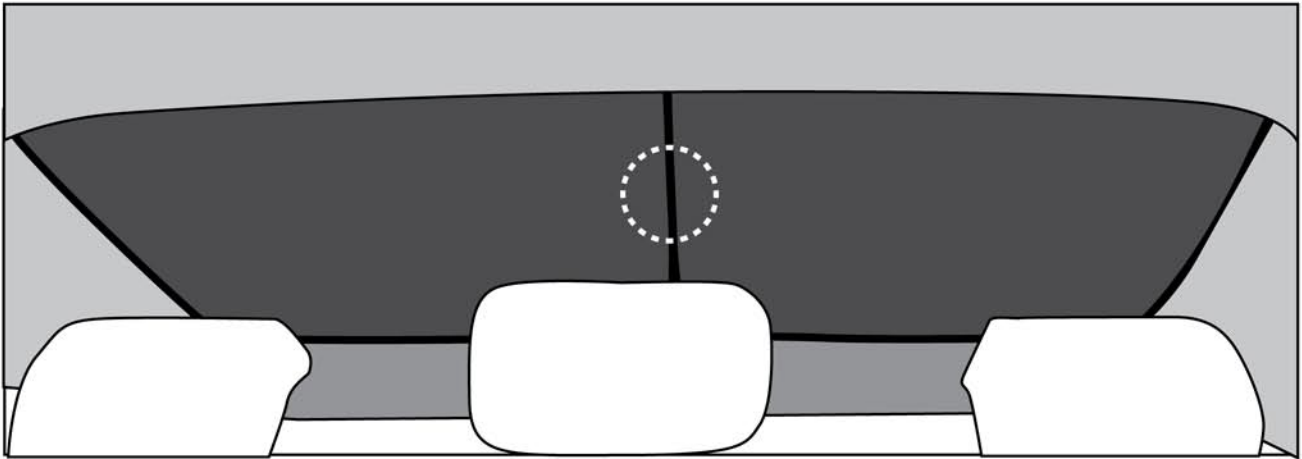

1

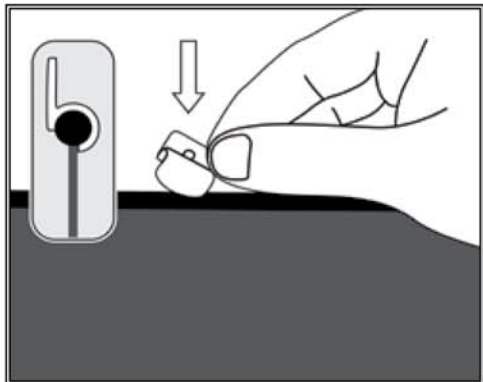
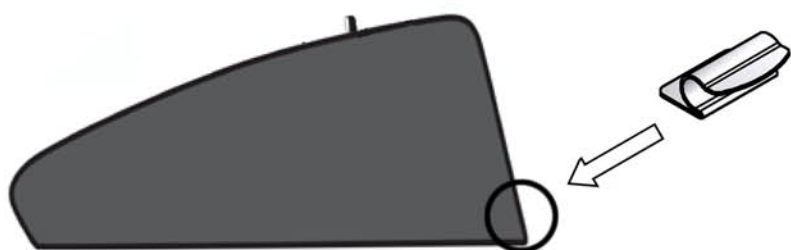
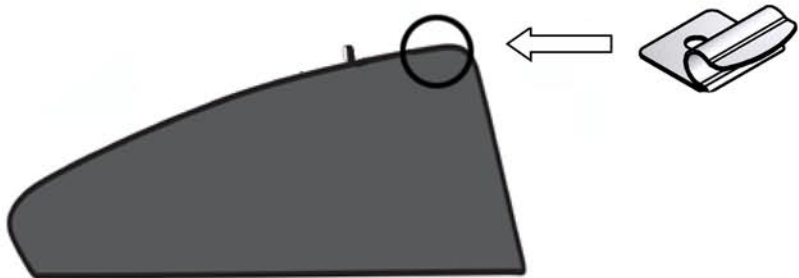

2

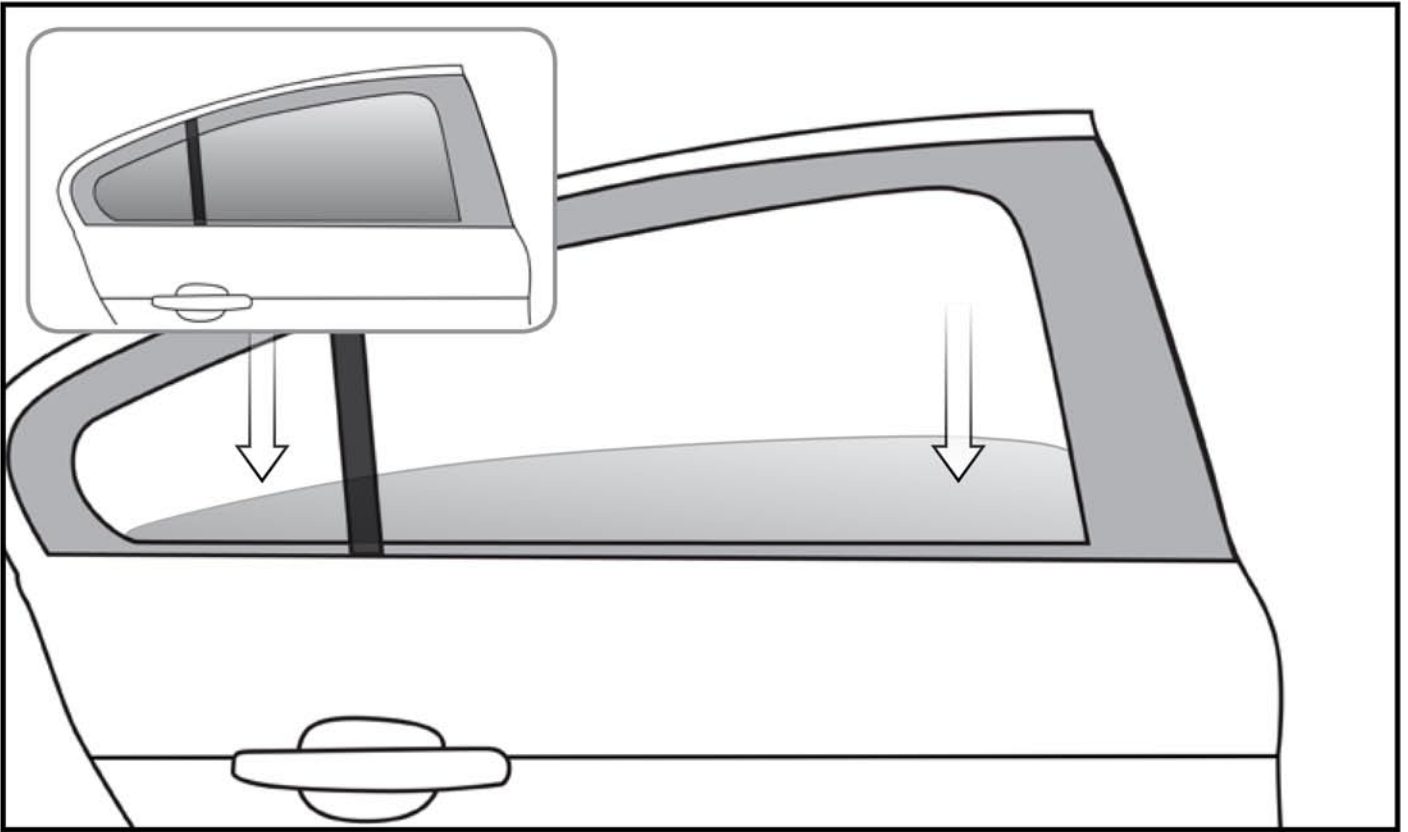

3

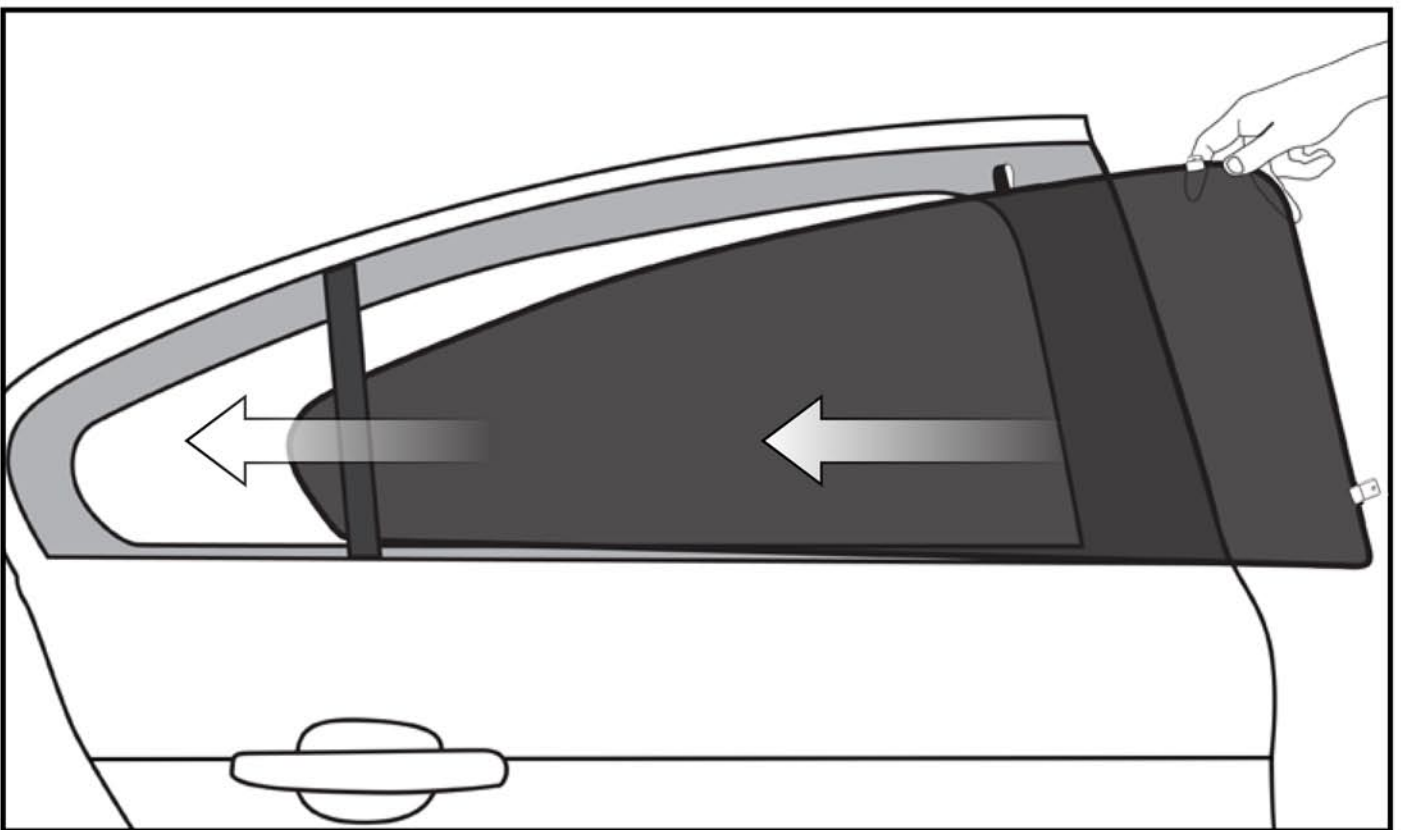

4

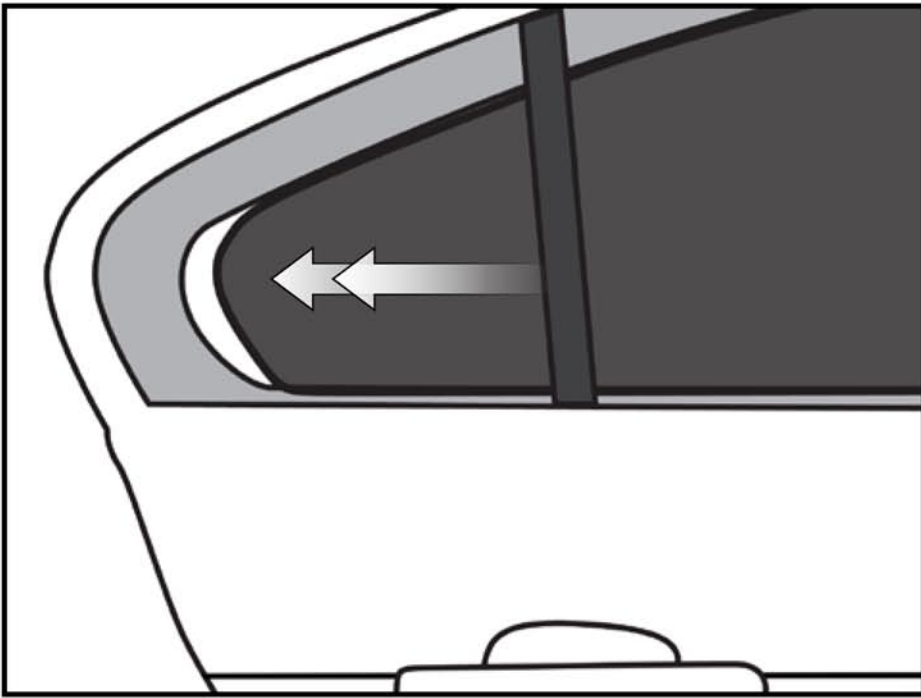

5

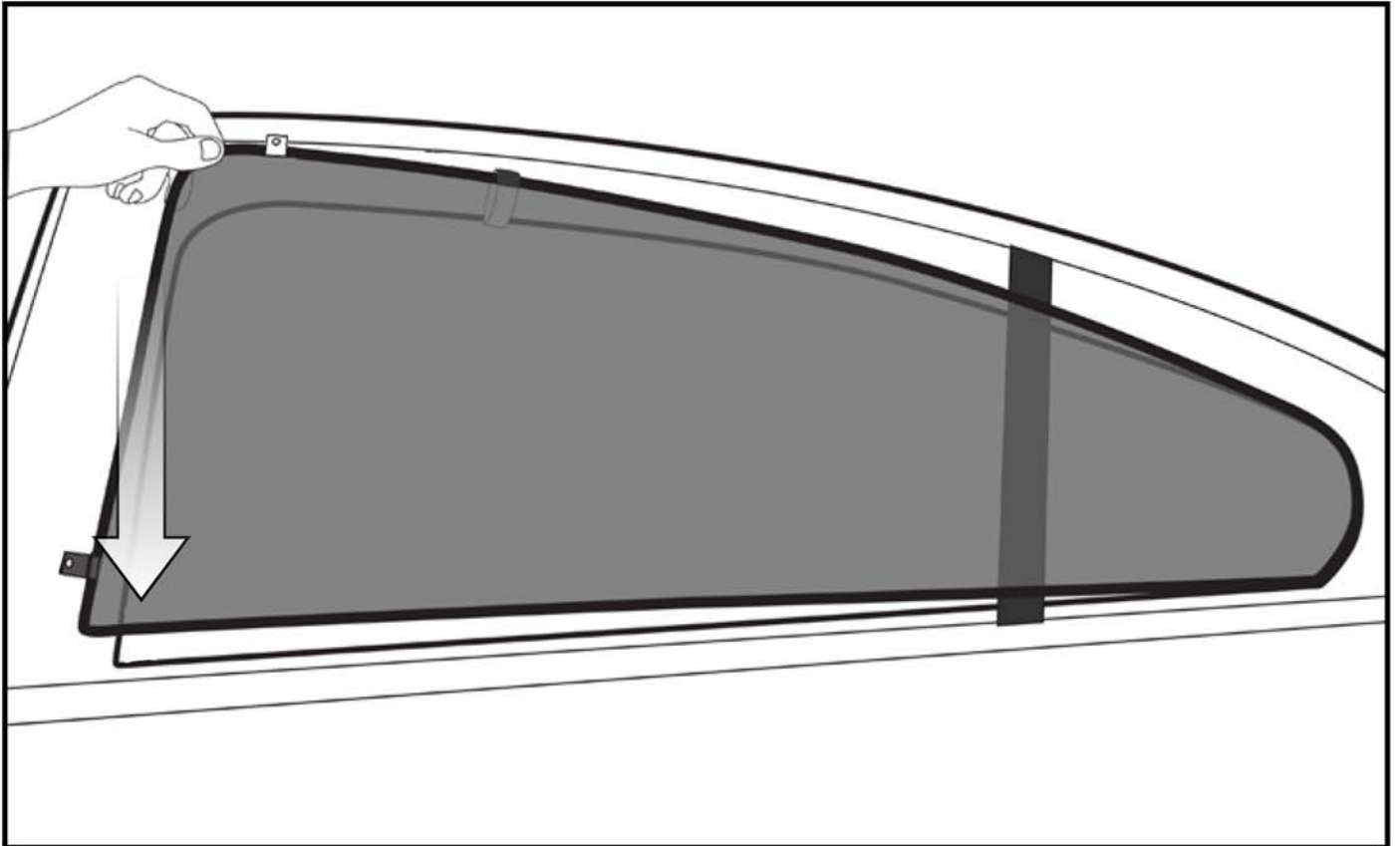

6

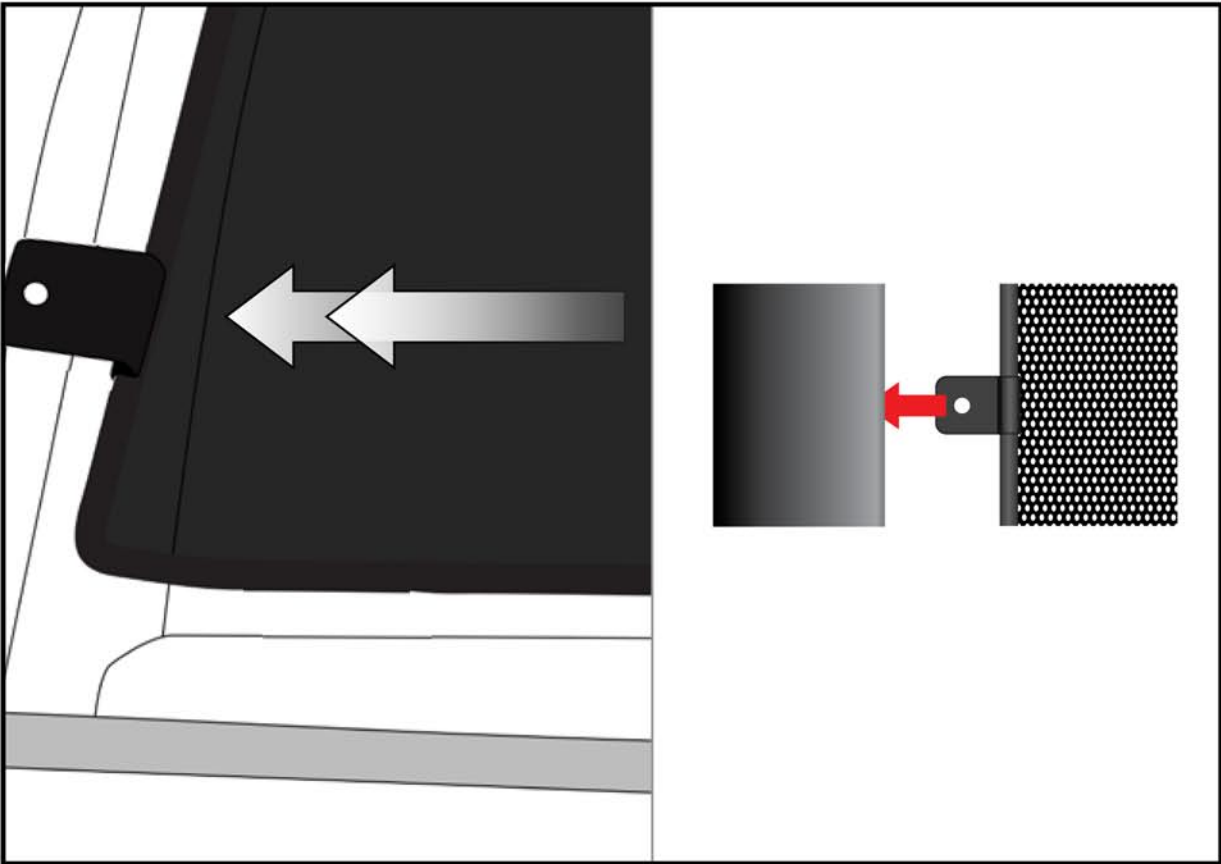

7

